

# JVC

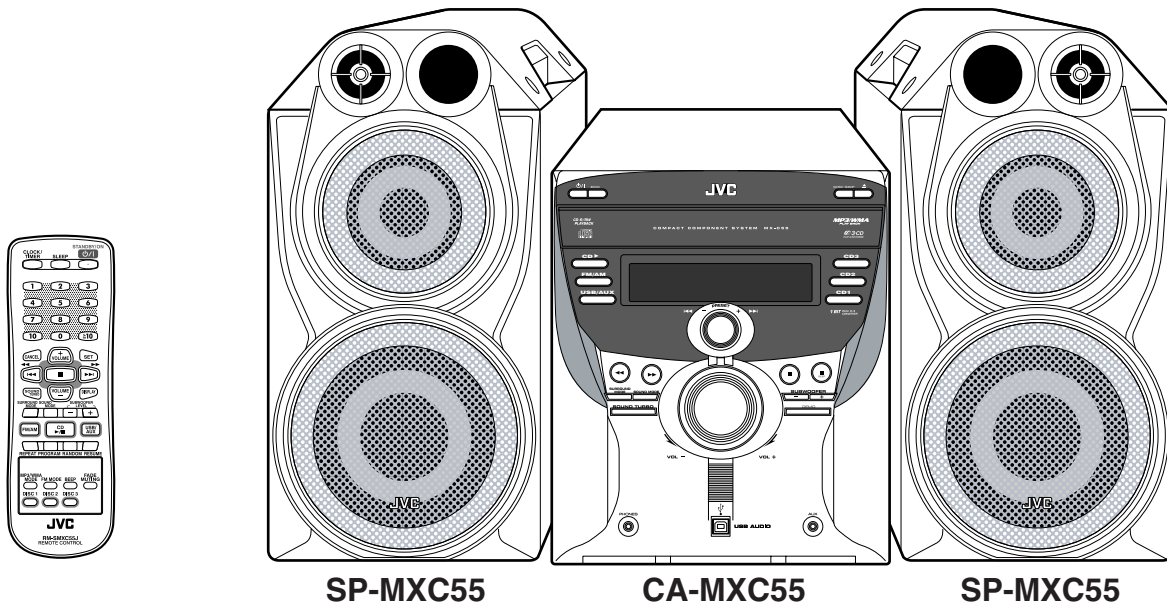

## COMPACT COMPONENT SYSTEM

# MX-C55

 – Consists of CA-MXC55 and SP-MXC55

SP-MXC55

CA-MXC55

SP-MXC55

COMPACT  
**disc**  
DIGITAL AUDIO

**MP3**  
PLAYBACK

# INSTRUCTIONS

### For Customer Use:

Enter below the Model No. and Serial No. which are located either on the rear, bottom or side of the cabinet. Retain this information for future reference.

Model No. \_\_\_\_\_

Serial No. \_\_\_\_\_

LVT1541-001A  
[J]

# Warnings, Cautions and Others

## Mises en garde, précautions et indications diverses

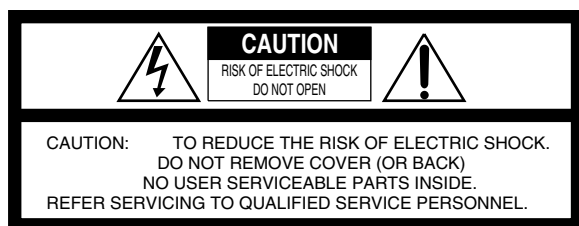

The lightning flash with arrowhead symbol, within an equilateral triangle is intended to alert the user to the presence of uninsulated "dangerous voltage" within the product's enclosure that may be of sufficient magnitude to constitute a risk of electric shock to persons.



The exclamation point within an equilateral triangle is intended to alert the user to the presence of important operating and maintenance (servicing) instructions in the literature accompanying the appliance.

**WARNING: TO REDUCE THE RISK OF FIRE OR ELECTRIC SHOCK, DO NOT EXPOSE THIS APPLIANCE TO RAIN OR MOISTURE.**

### CAUTION

To reduce the risk of electrical shocks, fire, etc.:

1. Do not remove screws, covers or cabinet.
2. Do not expose this appliance to rain or moisture.

### ATTENTION

Afin d'éviter tout risque d'électrocution, d'incendie, etc.:

1. Ne pas enlever les vis ni les panneaux et ne pas ouvrir le coffret de l'appareil.
2. Ne pas exposer l'appareil à la pluie ni à l'humidité.

### Caution — STANDBY/ON button!

Disconnect the mains plug to shut the power off completely (the STANDBY lamp goes off). When installing the apparatus, ensure that the plug is easily accessible.

The STANDBY/ON  button in any position does not disconnect the mains line.

- When the unit is on standby, the STANDBY lamp lights red.
- When the unit is turned on, the STANDBY lamp goes off.

The power can be remote controlled.

### Attention — Touche STANDBY/ON !

Déconnectez la fiche d'alimentation secteur pour mettre l'appareil complètement hors tension (le témoin STANDBY est éteint). Lors de l'installation de l'appareil, assurez-vous que la fiche soit facilement accessible.

La touche STANDBY/ON  , dans n'importe quelle position, ne déconnecte pas l'appareil du secteur.

- Quand l'appareil est en mode d'attente, le témoin STANDBY est allumé en rouge.
- Quand l'appareil est sous tension, le témoin STANDBY est éteint.

L'alimentation peut être télécommandée.

### For U.S.A.

This equipment has been tested and found to comply with the limits for a Class B digital device, pursuant to part 15 of the FCC Rules. These limits are designed to provide reasonable protection against harmful interference in a residential installation.

This equipment generates, uses and can radiate radio frequency energy and, if not installed and used in accordance with the instructions, may cause harmful interference to radio communications. However, there is no guarantee that interference will not occur in a particular installation. If this equipment does cause harmful interference to radio or television reception, which can be determined by turning the equipment off and on, the user is encouraged to try to correct the interference by one of the following measures:

Reorient or relocate the receiving antenna.

Increase the separation between the equipment and receiver.

Connect the equipment into an outlet on a circuit different from that to which the receiver is connected.

Consult the dealer or an experienced radio/TV technician for help.

### CAUTION

Changes or modifications not approved by JVC could void the user's authority to operate the equipment.

### For U.S.A.

#### For the main unit:

Declaration of Conformity

Model Number: MX-C55

Trade Name: JVC

Responsible Party: JVC Americas Corp.

Address: 1700 Valley Road, Wayne  
New Jersey 07470

Telephone Number: 973-317-5000

This device complies with Part 15 of FCC Rules. Operation is subject to the following two conditions: (1) This device may not cause harmful interference, and (2) this device must accept any interference received, including interference that may cause undesired operation.

### For Canada/pour le Canada

This class B digital apparatus complies with Canadian ICES-003.

Cet appareil numérique de la classe B est conforme à la norme NMB-003 du Canada.

### Note to CATV system installer:

This reminder is provided to call the CATV system installer's attention to Section 820-40 of the NEC which provides guidelines for proper grounding and, in particular, specifies that the cable ground shall be connected to the grounding system of the building, as close to the point of cable entry as practical.

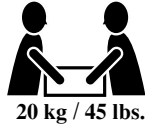

20 kg / 45 lbs.

**CAUTION!**

To avoid personal injury or accidentally dropping the unit, have two persons unpack, carry, and install the unit.

**ATTENTION!**

Pour éviter toute blessure personnelle ou chute accidentelle de l'appareil, faites déballer, transporter et installer l'appareil par deux personnes.

**IMPORTANT FOR LASER PRODUCTS**

1. CLASS 1 LASER PRODUCT
2. **CAUTION:** Do not open the top cover. There are no user serviceable parts inside the Unit; leave all servicing to qualified service personnel.
3. **CAUTION:** Visible and/or invisible class 1M laser radiation when open. Do not view directly with optical instruments.

**IMPORTANT POUR PRODUITS LASER**

1. PRODUIT LASER CLASSE 1
2. **ATTENTION:** N'ouvrez pas le couvercle supérieur. Il n'y a aucune pièce réparable par l'utilisateur à l'intérieur de l'appareil; confiez toute réparation à un personnel qualifié.
3. **ATTENTION:** Rayonnement laser visible et/ou invisible de classe 1M une fois ouvert. Ne pas regarder directement avec des instruments optiques.



[European Union only]

[Union européenne uniquement only]

**Caution: Proper Ventilation**

To avoid risk of electric shock and fire, and to prevent damage, locate the apparatus as follows:

- 1 Front:  
No obstructions and open spacing.
- 2 Sides/ Top/ Back:  
No obstructions should be placed in the areas shown by the dimensions below.
- 3 Bottom:  
Place on the level surface. Maintain an adequate air path for ventilation by placing on a stand with a height of 10 cm or more.

**Attention: Aération correcte**

Pour prévenir tout risque de décharge électrique ou d'incendie et éviter toute détérioration, installez l'appareil de la manière suivante:

- 1 Avant:  
Bien dégagé de tout objet.
- 2 Côtés/dessus/dessous:  
Assurez-vous que rien ne bloque les espaces indiqués sur le schéma ci-dessous.
- 3 Dessous:  
Posez l'appareil sur une surface plane et horizontale. Veillez à ce que sa ventilation correcte puisse se faire en le plaçant sur un support d'au moins dix centimètres de hauteur.

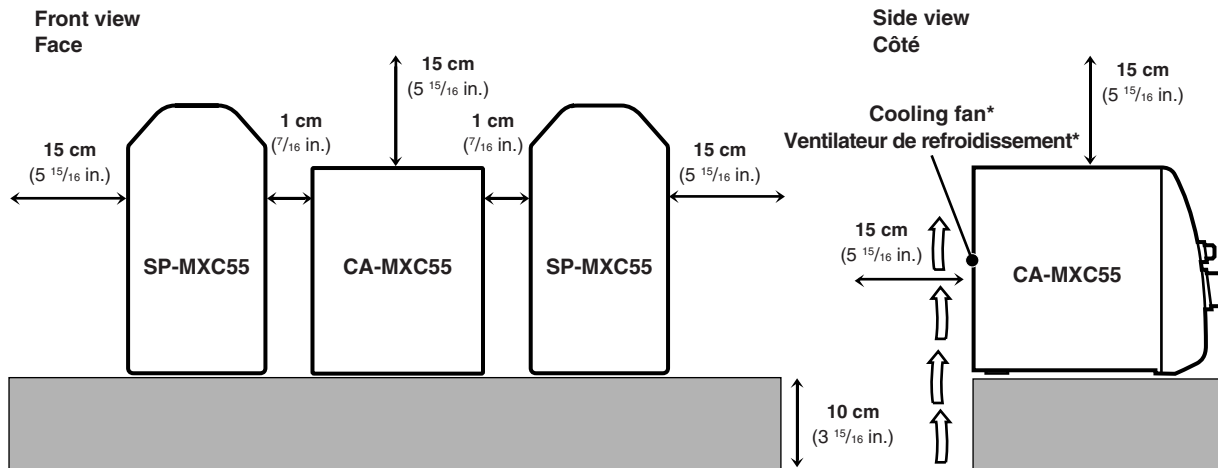

# Introduction

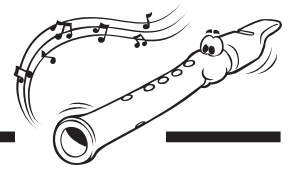

We would like to thank you for purchasing a JVC product. Before operating this unit, read this manual carefully and thoroughly to obtain the best possible performance from your unit, and retain this manual for future reference.

## About This Manual

This manual is organized as follows:

- The manual mainly explains operations using the buttons and controls on the unit. You can also use the buttons on the remote control if they have the same or similar names (or marks) as those on the unit. If operation using the remote control is different from that using the unit, it is then explained.
- Basic and common information that is the same for many functions is grouped in one place, and is not repeated in each procedure. For instance, we do not repeat the information about turning on/off the unit, setting the volume, changing the sound effects, and others, which are explained in the section “Common Operations” on pages 9 to 11.
- The following marks are used in this manual:



Gives you warnings and cautions to prevent damage or risk of fire/electric shock. Also gives you information which is not good for obtaining the best possible performance from the unit.



Gives you information and hints you should know.

## Precautions

### Installation

- Do not grasp the control knobs when moving or carrying the unit.
- Install in a place which is level, dry and neither too hot nor too cold—between 5°C (41°F) and 35°C (95°F).
- Install the unit in a location with adequate ventilation to prevent internal heat built-up in the unit.
- Leave sufficient distance between the unit and the TV.
- Keep the speakers away from the TV to avoid interference with TV.



DO NOT install the unit in a location near heat sources, or in a place subject to direct sunlight, excessive dust or vibration.

### Power sources

- When unplugging from the wall outlet, always pull the plug, not the AC power cord.



DO NOT handle the AC power cord with wet hands.

### Moisture condensation

Moisture may condense on the lens inside the unit in the following cases:

- After starting heating in the room
  - In a damp room
  - If the unit is brought directly from a cold to a warm place
- Should this occur, the unit may malfunction. In this case, leave the unit turned on for a few hours until the moisture evaporates, unplug the AC power cord, and then plug it in again.

### Others

- Should any metallic object or liquid fall into the unit, unplug the unit and consult your dealer before operating any further.
- If you are not going to operate the unit for an extended period of time, unplug the AC power cord from the wall outlet.



DO NOT disassemble the unit since there are no user serviceable parts inside.

If anything goes wrong, unplug the AC power cord and consult your dealer.

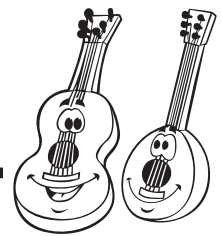

<b>Location of the Buttons and Controls .....</b>	<b>3</b>
Front Panel .....	3
Remote Control .....	5
<b>Getting Started .....</b>	<b>6</b>
Unpacking .....	6
Inserting the Batteries into the Remote Control .....	6
Connecting Antennas .....	6
Connecting Speakers .....	7
Canceling the Display Demonstration .....	8
<b>Common Operations .....</b>	<b>9</b>
Turning On or Off the Power .....	9
Setting the Clock .....	9
Selecting the Sources .....	9
Adjusting the Volume .....	10
Reinforcing the Bass Sound .....	10
Enjoying the Powerful sound—SOUND TURBO ...	10
Selecting the Sound Modes .....	11
Turning On or Off the Key-touch Tone (BEEP) .....	11
<b>Listening to the Radio .....</b>	<b>12</b>
Tuning in to a Station—Auto Search .....	12
Presetting Stations .....	12
Tuning in to a Preset Station .....	12
<b>Playing Back CDs .....</b>	<b>13</b>
Loading CDs .....	13
Playing Back CDs—All Disc and One Disc .....	13
Advanced CD Operations .....	15
Changing the MP3/WMA Playback Mode .....	17
Turning On or Off the Resume Play for MP3/WMA Disc .....	17
Programming the Playing Order of the Tracks —Program Play .....	18
Playing at Random—Random Play .....	19
Repeating Tracks or CDs—Repeat Play .....	19
Prohibiting Disc Ejection—Carrousel Lock .....	19
<b>Playing Back from the External Source .....</b>	<b>20</b>
Connecting to Your PC. ....	20
Connecting the Other Audio Equipment .....	21
<b>Using the Timers .....</b>	<b>22</b>
Using Daily Timer .....	22
Using Sleep Timer .....	23
<b>Maintenance .....</b>	<b>24</b>
<b>Troubleshooting .....</b>	<b>25</b>
<b>Specifications .....</b>	<b>26</b>

# Location of the Buttons and Controls

Be familiar with the buttons and controls on your unit.

## Front Panel

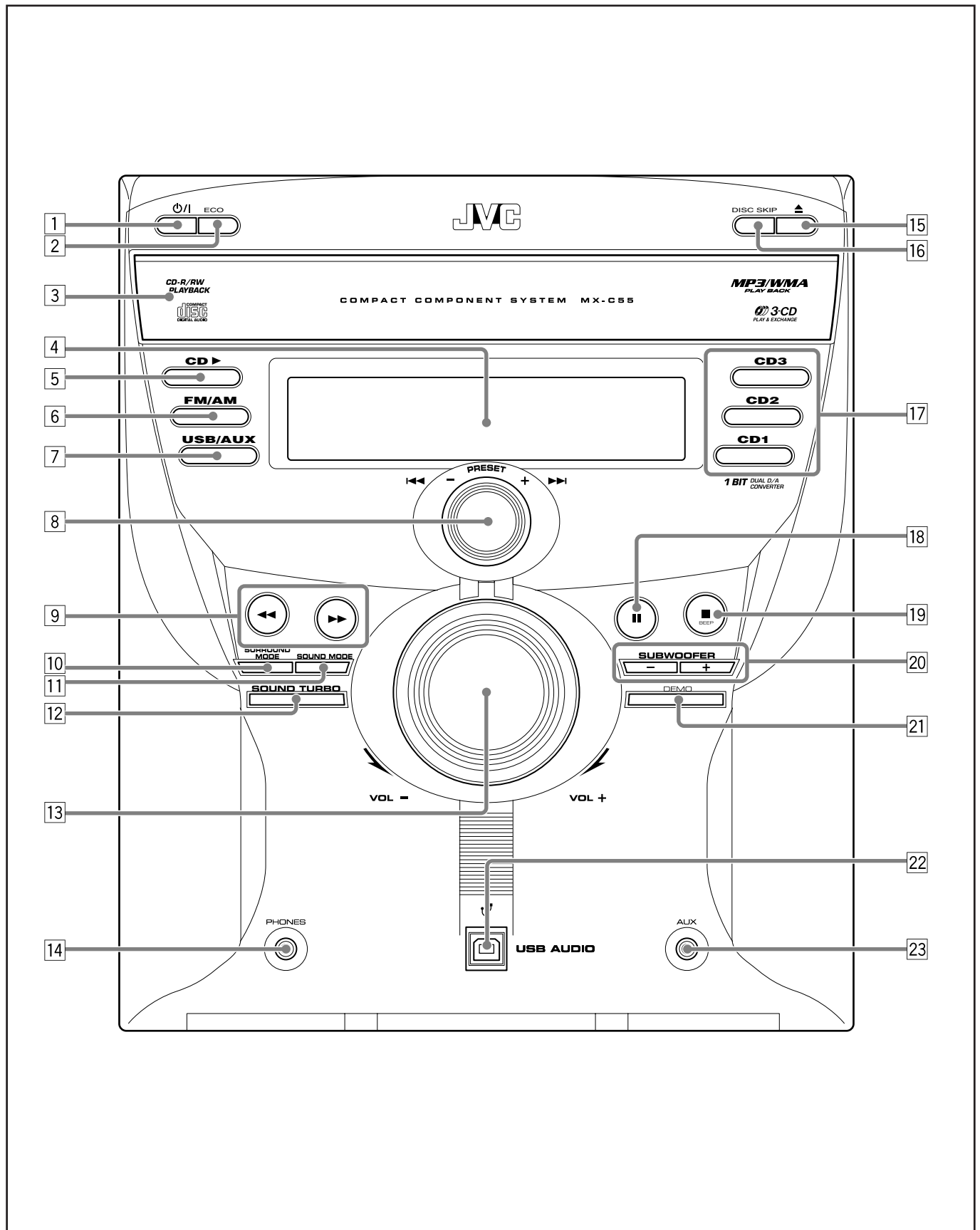

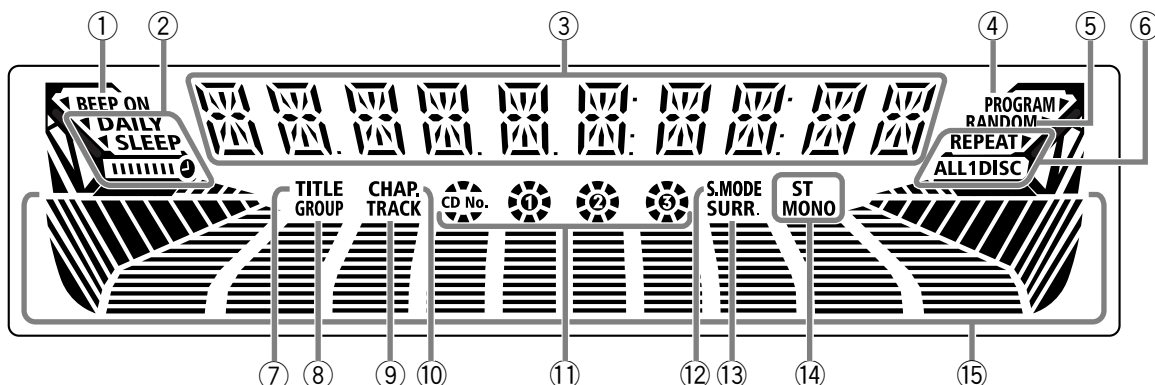
**Display Window**

See pages in the parentheses for details.

**Front Panel**

- 1 (power) button/Sandby lamp (9)
- 2 ECO button (9)
- 3 Carrousel
- 4 Display window
- 5 CD (play) button (9, 14-15, 17-18)  
*Pressing this button also turns on the unit.*
- 6 FM/AM button (9, 12)  
*Pressing this button also turns on the unit.*
- 7 USB/AUX button (9, 20-21)  
*Pressing this button also turns on the unit.*
- 8 PRESET +/-, /
- (reverse search/forward search) control (12, 16-17)
- 9 / (fast rewind/fast forward) buttons (12, 15)
- 10 SURROUND MODE button (11)
- 11 SOUND MODE button (11)
- 12 SOUND TURBO button (10)
- 13 VOL (volume) +/- control (10)
- 14 PHONES jack (10)
- 15 (carrousel open/close) button (13-15, 17-19)  
*Pressing this button also turns on the unit.*
- 16 DISC SKIP button (13, 15, 17)
- 17 Disc number buttons (CD1, CD2 and CD3) (14)  
*Pressing one of these buttons also turns on the unit.*
- 18 (pause) button (15)
- 19 (stop)/BEEP button (11)
- 20 SUBWOOFER +/- buttons (10)
- 21 DEMO button (8)
- 22 USB AUDIO jack (20)
- 23 AUX jack (21)

**Display Window**

- 1 BEEP indicator
- 2 Timer indicators
  - DAILY (daily timer), SLEEP (sleep timer) and (timer) indicators.
- 3 Main display
  - Shows the source name, frequency, etc.
- 4 PROGRAM indicator
- 5 RANDOM indicator
- 6 REPEAT mode indicators
  - REPEAT 1, REPEAT 1 DISC, REPEAT ALL DISC, ALL DISC and 1 DISC indicators
- 7 TITLE indicator
- 8 GROUP indicator
- 9 TRACK indicator
- 10 CHAP. (chapter) indicator
- 11 CD No. (CD number) indicators
  - The corresponding CD No. lights up when a CD is loaded on the carrousel.
  - The current CD No. flashes.
- 12 S. MODE (sound mode) indicator
- 13 SURR. (surround) indicator
- 14 Tuner operation indicators
  - ST (stereo) and MONO (monaural) indicators
- 15 Volume level, Subwoofer level, Sound Mode pattern indicators and Level meter.



## Remote Control

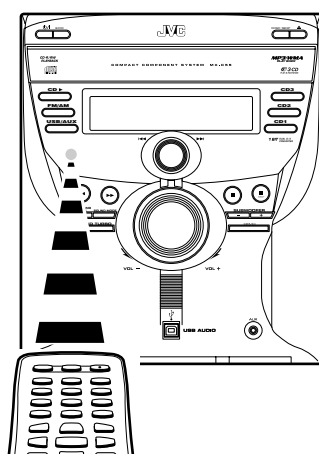
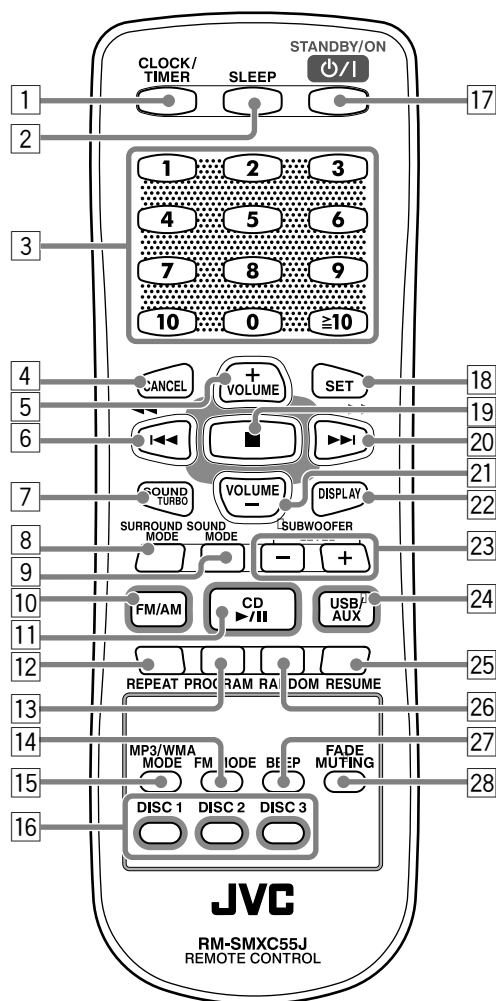

When using the remote control, point it at the remote sensor on the front panel.

## Remote Control

- 1 CLOCK/TIMER button (9, 22-23)
- 2 SLEEP button (23)
- 3 Number buttons (12, 16-18)
- 4 CANCEL button (9, 18, 23)
- 5 VOLUME + button (10)
- 6 ◀◀/◀◀ (reverse search/fast reverse) button (9, 12, 15-17, 19, 22-23)
- 7 SOUND TURBO button (10)
- 8 SURROUND MODE button (11)
- 9 SOUND MODE button (11)
- 10 FM/AM button (9, 12)  
*Pressing this button also turns on the unit.*
- 11 CD ▶/⏸ (play/pause) button (13-15, 17-18)  
*Pressing this button also turns on the unit.*
- 12 REPEAT button (13, 15, 19)
- 13 PROGRAM button (18)
- 14 FM MODE button (12)
- 15 MP3/WMA MODE button (17)
- 16 Disc number buttons (DISC1, DISC2 and DISC3) (14-15, 18-19)
- 17 ⏻/⏻ STANDBY/ON button (23)
- 18 SET button (9, 12, 18, 22-23)
- 19 ■ (stop) button (13-15, 18-19)
- 20 ▶▶/▶▶ (forward search/ fast forward) button (9, 12, 15-17, 19, 22-23)
- 21 VOLUME - button (10)
- 22 DISPLAY button (9)
- 23 SUBWOOFER LEVEL +/- buttons (10)
- 24 USB/AUX button (9, 20-21)  
*Pressing this button also turns on the unit.*
- 25 RESUME button (17)
- 26 RANDOM button (19)
- 27 BEEP button (11)
- 28 FADE MUTING button (10)



## Unpacking

After unpacking, check if you have all the following accessories.

The number in the parentheses indicates the quantity of the pieces supplied.

- AM loop antenna (1)
- FM antenna (1)
- Remote control (1)
- Batteries (2)

If any is missing, consult your dealer immediately.

## Inserting the Batteries into the Remote Control

Insert the batteries—R6P(SUM-3)/AA(15F)—into the remote control, by matching the polarity (+ and -) on the batteries with the + and - markings on the battery compartment. When the remote control can no longer operate the unit, replace both batteries at the same time.

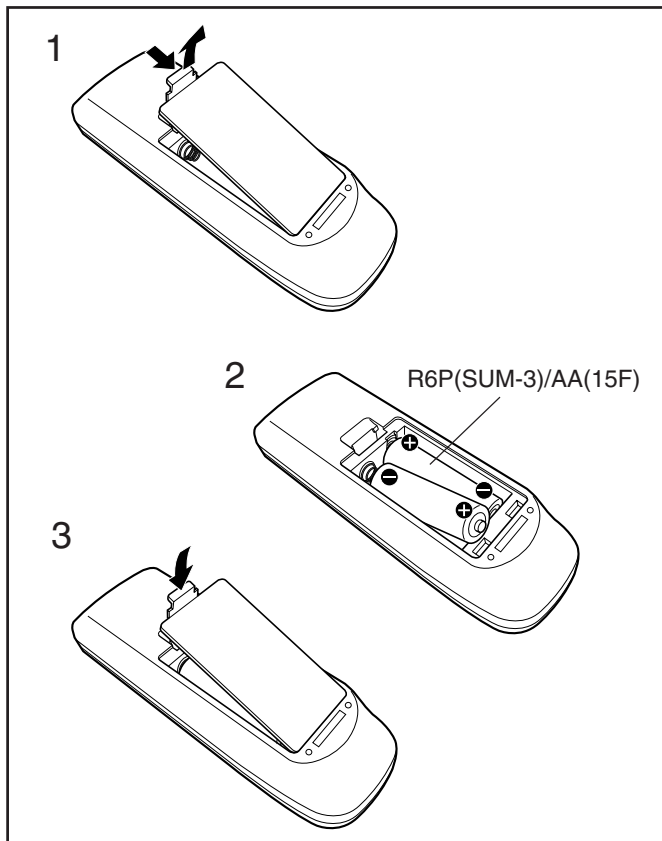

- DO NOT use an old battery together with a new one.
- DO NOT use different types of batteries together.
- DO NOT expose batteries to heat or flame.
- DO NOT leave the batteries in the battery compartment when you are not going to use the remote control for an extended period of time. Otherwise, it will be damaged from battery leakage.

## Connecting Antennas

### FM antenna

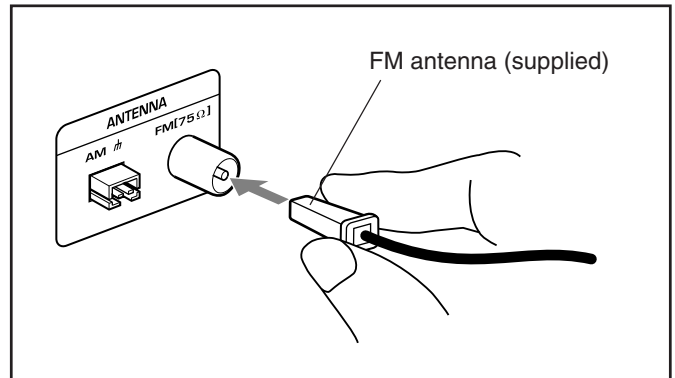

**1** Connect the FM antenna to the FM [75 Ω] coaxial terminal.

**2** Extend the FM antenna.

**3** Fix it in the position which gives you the best reception, on the wall, etc.



#### About the supplied FM antenna

The FM antenna supplied with this unit can be used as temporary measure. If reception is poor, you can connect an outdoor FM antenna.

#### To connect an outdoor FM antenna

Before connecting it, disconnect the supplied FM antenna.

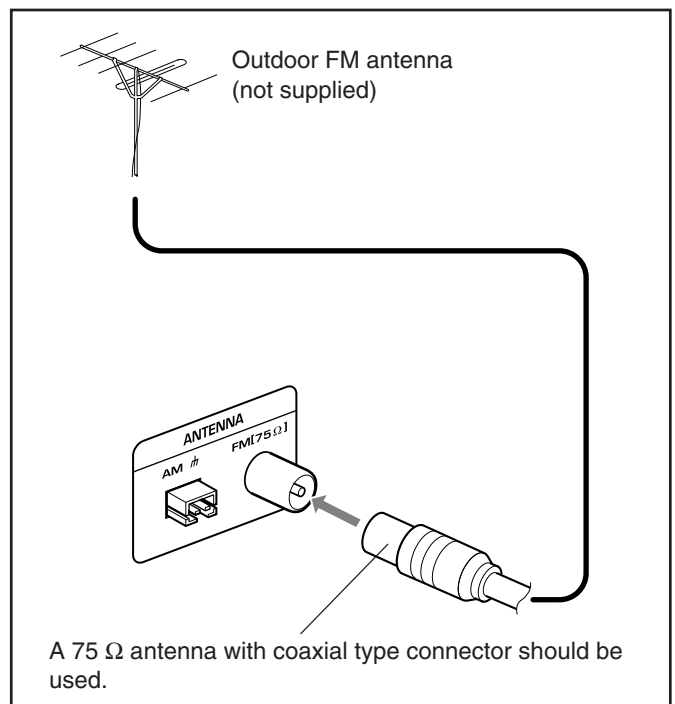

## AM antenna

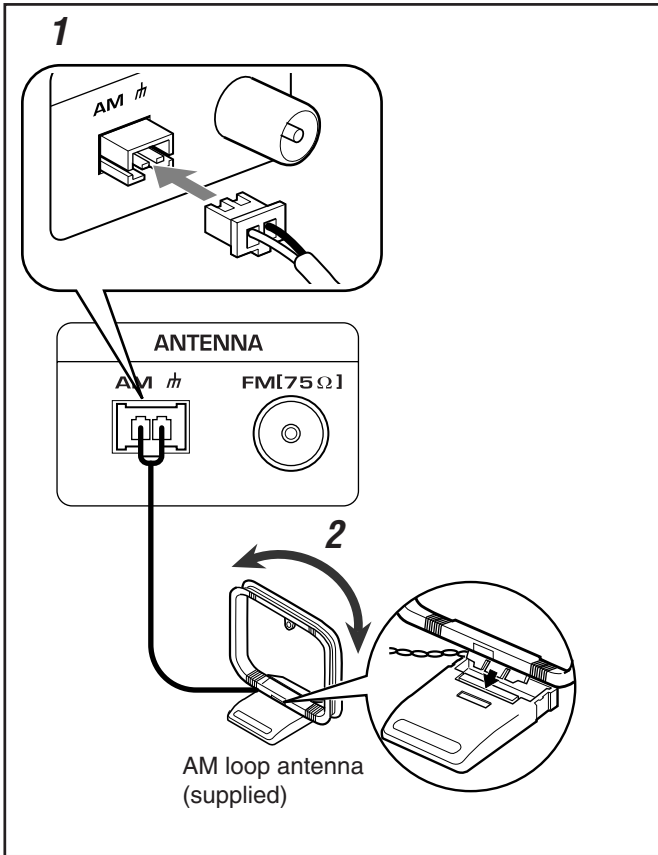

**1** Connect the AM antenna to the AM terminal on the rear of the unit.

**2** Turn the AM loop antenna until you have the best reception.



### For better reception of both FM and AM

- Make sure the antenna conductors do not touch any other terminals and connecting cords.
- Keep the antennas away from metallic parts of the unit, connecting cords, and the AC power cord.

## Connecting Speakers



DO NOT carry the speaker by holding the tube duct (on the top of the speaker).

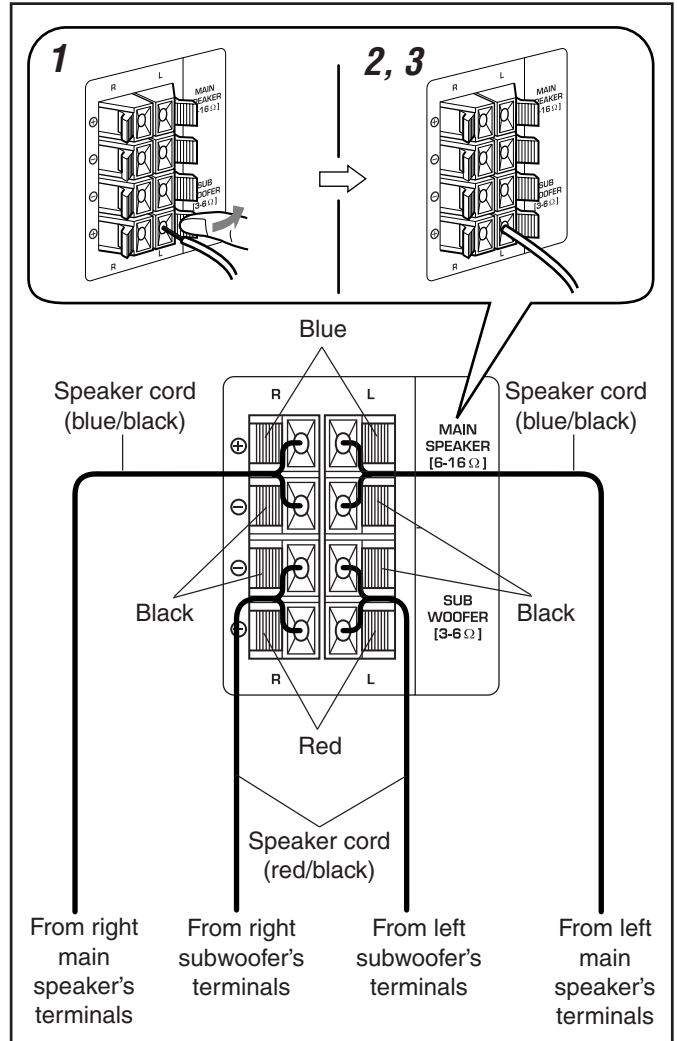

**1** Press and hold the clamp of the speaker terminal on the rear of the unit.

**2** Insert the end of the speaker cord into the terminal.

Match the colors (polarity): Blue (+) to blue (+) and black (-) to black (-); red (+) to red (+) and black (-) to black (-).

**3** Release the finger from the clamp.

### IMPORTANT:

- Use only speakers with the same speaker impedance as indicated by the speaker terminals on the rear of the unit.
- DO NOT connect more than one speaker to one speaker terminal.



---

**NOW** you are ready to plug in the unit and other connected equipment.

## **Canceling the Display Demonstration**

---

When connecting the AC power cord into a wall outlet, the unit automatically starts the display demonstration.

### **On the unit ONLY:**

**To cancel the display demonstration,**  
Press and hold DEMO for 2 seconds while the display demonstration is shown on the display until “DEMO OFF” is displayed.

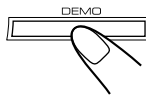

### **When you press other buttons**

The display demonstration stops temporarily. It will start automatically again (if no operation is done for 2 minutes) until you cancel it.

### **To start the display demonstration manually**

Press and hold DEMO again for more than 2 seconds.

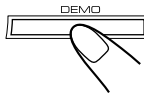



# Common Operations

## Turning On or Off the Power

To turn on the unit, press  so that the standby lamp goes off.

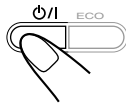
POWER ON



To turn off the unit (on standby), press  again so that the standby lamp lights up.

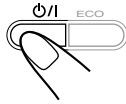

A little power is always consumed even while the unit is on standby.

To save the power consumption while on standby, press ECO.

All the indicators in the display window including the display demonstration disappears.

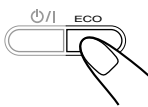

To switch off the power supply completely, unplug the AC power cord from the AC outlet.



**When you unplug the AC power cord or if a power failure occurs**

The clock is reset to “-- : --” soon, while the tuner preset stations (see page 12) will be erased in a few days.

## Setting the Clock

Before operating the unit any further, first set the clock built in this unit. You can set the clock whether the unit is on or off.



**On the remote control ONLY:**

**1** Press CLOCK/TIMER.

AM 12:00



“CLOCK” flashes on the display, then “AM 12:00” appears.  
The hour digit starts flashing.

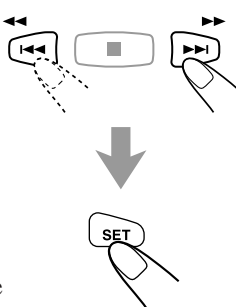

**2** Press  or  to adjust the hour, then press SET.

AM 7:00



The minute digits start flashing on the display.

- If you want to correct the hour after pressing SET, press CANCEL. The hour digits start flashing again.

**3** Press  or  to adjust the minute, then press SET.

CLOCK OK

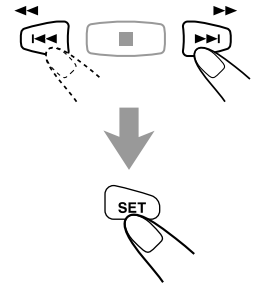

### To check the clock time

Press DISPLAY while playing any source.

- To return to the source indication, press DISPLAY.



**While the time indication appears on the display**

If you press any button or turn any control, the time indication returns to the source indication.

### To adjust the clock again

If the clock has been previously adjusted, you need to press CLOCK/TIMER repeatedly until “CLOCK” is selected.

- Each time you press the button, the clock/timer setting modes change as follows:

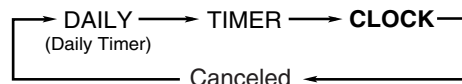

**If there is a power failure**

The clock loses the setting and is reset to “-- : --.” You need to set the clock again.

## Selecting the Sources

To listen to the radio, press FM/AM. (See page 12.)

To playback CDs, press CD . (See pages 13 – 19.)

To select the external equipment as a source, press USB/AUX.

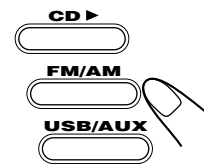

When you press the play button for a particular source (CD , FM/AM, USB/AUX), the unit turns on (and the unit starts playing the source if it is ready).

## Adjusting the Volume

You can adjust the volume level only while the unit is turned on.

Turn the VOL control clockwise to increase the volume or counterclockwise to decrease it.

- The volume level can be adjusted in 32 steps (VOL MIN, VOL 1 — VOL 30, and VOL MAX).

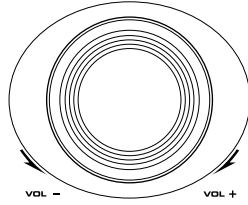

VOL 14

When using the remote control, press VOLUME + to increase the volume or press VOLUME – to decrease it.



### For private listening

Connect a pair of headphones to the PHONES jack. No sound comes out of the speakers. Be sure to turn down the volume before connecting or putting on headphones.



Always set the volume to the minimum before starting any source. If the volume is set to extremely high level, a sudden blast of sound can damage your hearing, speakers and/or headphones.

- If you have turned off (on standby) the unit with the volume level set at more than level “15,” the volume level will be automatically set at level “15” next time you turn on the unit.

### To turn off the volume level temporarily

Press FADE MUTING on the remote control. The volume level gradually decreases to “VOL MIN.”

To restore the sound, press the button again.



## Reinforcing the Bass Sound

Press SUBWOOFER + to increase the subwoofer sound or SUBWOOFER – to decrease it.

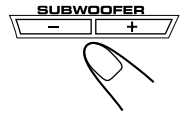

- The subwoofer level can be adjusted in 3 steps (SWOOFER 0 — SWOOFER 2).

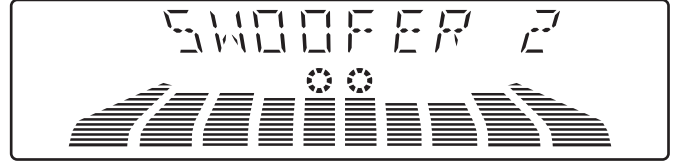

When using the remote control, press SUBWOOFER LEVEL + to increase the subwoofer sound or press SUBWOOFER LEVEL – to decrease it.

## Enjoying the Powerful Sound—SOUND TURBO

Using SOUND TURBO, harder-hitting beats intensify your listening experience even at low sound levels.

SOUND TURBO also works even when the song has no “beat,” such as classical music, so that you can listen to the rich sound even at low sound levels.

Press SOUND TURBO.

“TURBO ON” appears on the display.

- Each time you press the button, SOUND TURBO turns on and off alternately.

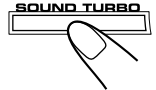

TURBO ON

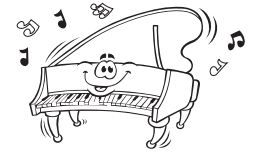

## Selecting the Sound Modes

You can select one of the 6 preset sound modes (3 surround modes and 3 sound modes).

To select the sound modes, press SOUND MODE repeatedly until the desired sound mode appears on the display.

- The S. MODE indicator also lights up.

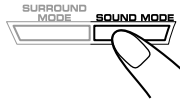

ROCK

S. MODE indicator

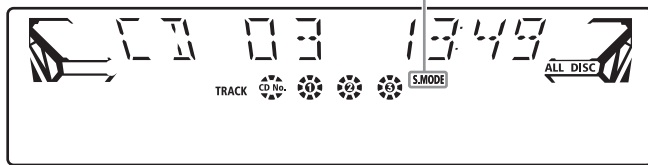

- Once you press SOUND MODE, the current sound mode appears on the display. Each time you press the button, the sound modes change as follows:

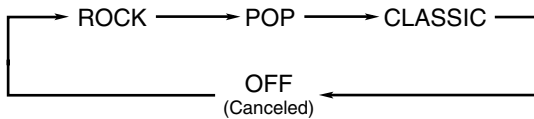

- ROCK** : Boosts low and high frequency. Good for acoustic music.
- POP** : Good for vocal music.
- CLASSIC** : Good for classical music.
- OFF** : Cancels the sound mode.

To select the surround modes, press SURROUND MODE repeatedly until the desired surround mode appears on the display.

- The SURR. indicator also lights up.

DANCE

SURR. indicator

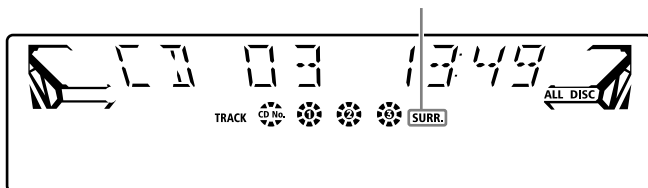

- Once you press SURROUND MODE, the current surround mode appears on the display. Each time you press the button, the surround modes change as follows:

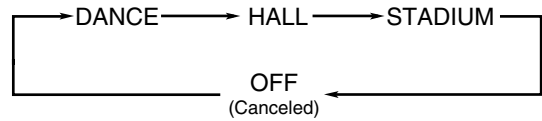

- DANCE** : Increases resonance and bass.
- HALL** : Adds depth and brilliance to the sound.
- STADIUM** : Adds clarity and spreads the sound, like in an outdoor stadium.
- OFF** : Cancels the surround mode.



Only one of the sound modes or surround modes can be selected at a time.

## Turning On or Off the Key-touch Tone (BEEP)

If you do not want the key-touch tone to beep each time you press a button or turn a control, you can deactivate it.

Press and hold BEEP for more than 2 seconds.



BEEP OFF

When using the remote control, press BEEP.

- Each time you press the button, the key-touch tone turns on and off alternately.

# Listening to the Radio



## Tuning in to a Station—Auto Search

### 1 Press FM/AM.

The unit automatically turns on and tunes in to the previously tuned station (either FM or AM).

- Each time you press the button, the band alternates between FM and AM.

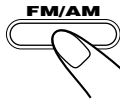

### 2 Start searching for stations.

**On the unit:**

Press and hold **▶▶** or **◀◀** for more than 1 second.

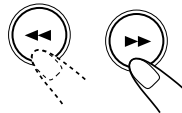

**On the remote control:**

Press and hold **▶▶/▶▶** or **◀◀/◀◀** for more than 1 second.

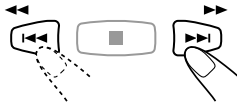

The unit starts searching for stations and stops when a station of sufficient signal strength is tuned in to. If a program is broadcast in stereo, the ST (stereo) indicator lights up.

**To stop during searching,** press **▶▶** or **◀◀** (**▶▶/▶▶** or **◀◀/◀◀** on the remote control).



When you press **▶▶** or **◀◀** (**▶▶/▶▶** or **◀◀/◀◀** on the remote control) briefly and repeatedly

The frequency changes step by step.

### To change the FM reception mode

When an FM stereo broadcast is hard to receive or noisy, press FM MODE on the remote control so that “MONO” appears and the MONO indicator also lights up on the display. Reception improves.



**To restore the stereo effect,** press FM MODE again so that “STEREO” appears on the display.

In this stereo mode, you can hear stereo sounds when a program is broadcast in stereo.

## Presetting Stations

**You can preset 30 FM and 15 AM stations.**

In some cases, test frequencies have been already memorized for the tuner since the factory examined the tuner preset function before shipment. This is not a malfunction. You can preset the stations you want into memory by following the presetting method.

- There is a time limit in doing the following steps. If the setting is canceled before you finish, start from step 2 again.

**On the remote control ONLY:**

### 1 Tune in to the station you want to preset.

- See “Tuning in to a Station—Auto Search.”



### 2 Press SET.



### 3 Press ▶▶/▶▶ or ◀◀/◀◀ to select a preset number.

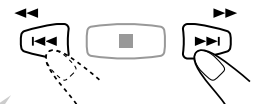
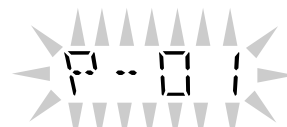

### 4 Press SET again.



The tuned station in step 1 is stored in the preset number selected in step 3.

- Storing a new station on a used number erases the previously stored one.



When you unplug the AC power cord or if a power failure occurs

The preset stations will be erased in a few days. If this happens, preset the stations again.

## Tuning in to a Preset Station

### 1 Press FM/AM.

The unit automatically turns on and tunes in to the previously tuned station (either FM or AM).

- Each time you press the button, the band alternates between FM and AM.



### 2 Select a preset number.

**On the unit:**

Turn the PRESET +/- control.

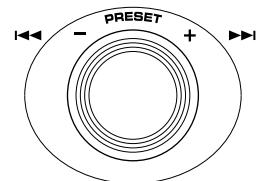

**On the remote control:**

Press the number button(s).

Ex.: For preset number 5, press 5.

For preset number 15, press  $\geq 10$ , 1 then 5.

For preset number 25, press  $\geq 10$ , 2 then 5.

For preset number 30, press  $\geq 10$ , 3 then 0.

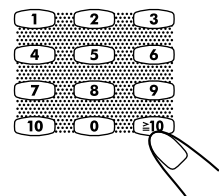

# Playing Back CDs

This unit has been designed to playback the following CDs:

- Audio CD
- CD-R (CD-Recordable)
- CD-RW (CD-ReWritable)
- MP3/WMA disc (MP3/WMA files recorded on a CD-R or CD-RW)\*

## When playing a CD-R or CD-RW

- User-edited CD-Rs (CD-Recordable) and CD-RWs (CD-ReWritable) can be played back when they are already “finalized.”
- Before playing back CD-Rs or CD-RWs, read their instructions or cautions carefully.
- Some CD-Rs or CD-RWs may not be played back on this unit because of their disc characteristics, damage or stain on them, or if the player’s lens is dirty.

## Important notices:

- In general, you will have the best performance by keeping your CDs and the mechanism clean.
  - Store CDs in their cases, and keep them in cabinets or on shelves.
  - Keep the unit’s carousel closed when not in use.
- Continuous use of irregular shaped discs (heart-shape, octagonal, etc.) can damage the disc rotating mechanism.



- CD-RWs may require a longer readout time since the reflectance of CD-RWs is lower than for regular CDs.

## \*For MP3/WMA discs

- This unit manages files and folders on MP3/WMA discs as “tracks” and “albums.”
- When playing an MP3/WMA disc, you can choose either TRACK mode or ALBUM mode. (See also page 17.)
- Playback order of the MP3/WMA files (tracks) recorded on a disc are determined by the writing (or encoding) application; therefore, playback order may be different from the one you have intended while recording the files and the folders.
- This unit shows the file (track) names and the ID3v1/1.1 tags (only “Title” and “Artist”) on the display after the file starts play; however, there is a limitation on available characters and some file names and ID3v1/1.1 tags are not shown correctly.



## More about MP3/WMA discs

- MP3 discs (either CD-R or CD-RW) require a longer readout time. (It varies due to the complexity of the recording configuration.)
- When making an MP3 disc, select ISO 9660 Level 1 or Level 2 as the disc format.
- This unit does not support multisession recording.
- This unit can play MP3 files only with the following file extensions—“.MP3,” “.Mp3,” “.mP3,” and “.mp3.”
- Non-MP3/WMA files are ignored. If non-MP3/WMA files are recorded together with MP3/WMA files, this unit will take a longer time to scan the disc. It may also cause the unit to malfunction.
- Some MP3/WMA discs may not be played back because of their disc characteristics or recording conditions.

## Loading CDs

### 1 Press ▲.

The unit automatically turns on and the carousel comes out.

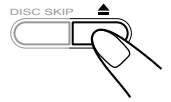

### 2 Place a disc correctly on the front recesses of the disc tray, with its label side up.

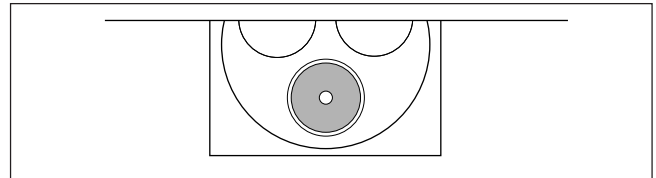

- When using a CD single (8 cm), place it on the inner recess of the disc tray.

### 3 If you wish to load the second and third discs, press DISC SKIP on the unit.

Each time you press DISC SKIP, the disc tray rotates by 120°.



### 4 Press ▲ again.

The carousel closes.

## For Audio CD:

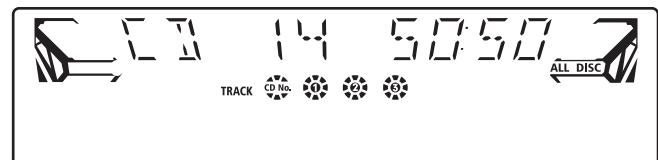

## For MP3/WMA disc:

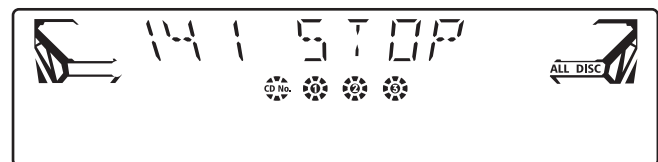

## Playing Back CDs—All Disc and One Disc

You can play all loaded CDs continuously—All disc playback, or one selected disc—One disc playback.

### All disc playback

#### On the remote control ONLY:

### 1 Load CDs.

- If the current playing source is not CD, press CD ►/II, then ■ before going to the next step.



**2** Press REPEAT repeatedly until the ALL DISC indicator lights up on the display.



ALL DISC indicator

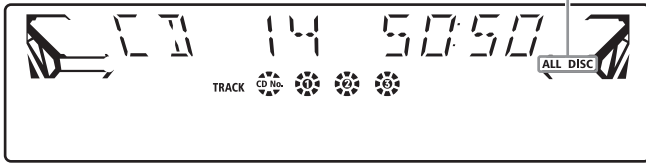

**3** Press one of the disc number buttons (DISC1, DISC2 or DISC3) for the disc you want to start to playback from.

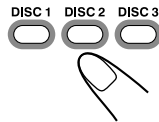

CD playback starts from the first track of the selected disc.

- Pressing CD ►/|| instead of the disc number buttons starts playing back if a CD is on the tray.

**For Audio CD:**

Current track number      Elapsed playing time

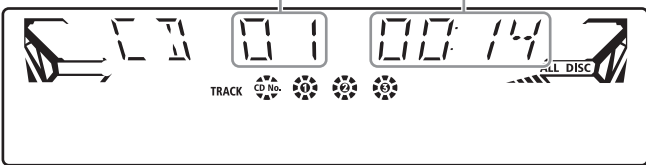

**For MP3/WMA disc:**

- When the playback mode is the ALBUM mode (See also page 17.); “current album number”, “current file name, track title and artist name” then “current track number and elapsed playing time” are displayed in order.

Current album number

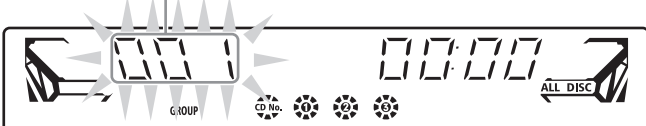

Current file name, track title and artist name scroll.

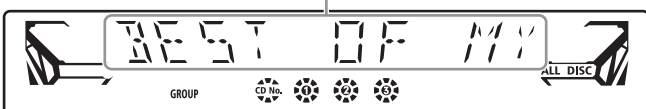

Current track number of the current album

Elapsed playing time



- When the playback mode is the TRACK mode (See also page 17.); “current file name, track title and artist name” and “current track number and elapsed playing time” are displayed in order.

Current file name, track title and artist name scroll.

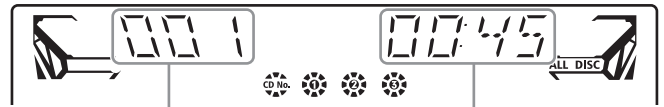
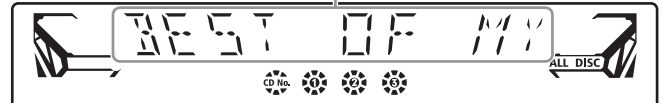

Current track number\*

Elapsed playing time

- \* In the TRACK mode, the unit manages files (tracks) on the MP3/WMA disc only. Folders (albums) are not recognized.

When the track includes the ID3v1/1.1 tags, “Title” and “Artist” will scroll after the track title.

- “<TITLE>” appears before the content of “Title” scrolls and “<ARTIST>” appears before the content of “Artist” scrolls.

**To stop playback, press ■.**

- For MP3/WMA disc, this unit can store the number of the track that you have stopped playback. By pressing CD ► (CD ►/|| on the remote control), you can start playback again from the beginning of the same track—Resume play (see also page 17).

**To remove the disc, press ▲.**



**CD playback sequence**

When 3 CDs\*\* are loaded on the disc trays, they are played in one of the following sequences.

- When CD1 is pressed : CD1 ⇒ CD2 ⇒ CD3 (then stops)
- When CD2 is pressed : CD2 ⇒ CD3 ⇒ CD1 (then stops)
- When CD3 is pressed : CD3 ⇒ CD1 ⇒ CD2 (then stops)

\*\* When only 2 CDs are loaded, they are played in the same order, but the disc tray without a CD is skipped.



- If ▲ is pressed while one of the three discs is being played back, the playback of the disc is continued, while the other two discs are ejected.
- During this time, DISC SKIP is unavailable.

## One disc playback

When 2 or 3 CDs are loaded on the disc trays, you can select one particular disc to be played back.

### On the remote control ONLY:

#### 1 Load CDs.

- If the current playing source is not CD, press CD ►/■, then ■ before going to the next step.

#### 2 Press REPEAT repeatedly so that the 1DISC indicator lights up on the display.

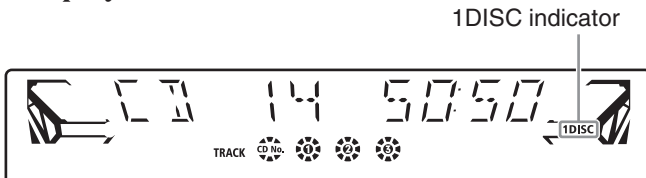

#### 3 Press one of the disc number buttons (DISC1, DISC2 or DISC3) you want to playback.

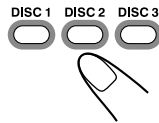

Playback stops when all tracks of the selected disc are played once and resumes to All disc play.

#### To stop playback, press ■.

- For MP3/WMA disc, this unit can store the number of the track that you have stopped playback. By pressing CD ► (CD ►/■ on the remote control), you can start playback again from the beginning of the same track—Resume play (see also page 17).

#### To remove the disc, press ▲.

To exit from One disc playback, press REPEAT repeatedly so that ALL DISC indicator lights up on the display.



The following operations will also cancel the One disc playback and restore All disc playback

- When the playback is stopped.
- When the unit is turned off.
- When the carousel is opened.
- When the playing source is changed.

## Advanced CD Operations

During the playback of CD, the following operations are available.

#### To skip to the another CD in the carousel

Press DISC SKIP on the unit.

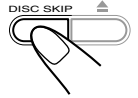

#### To stop playback for a moment

During playback, press ■.

“PAUSE” appears on the display.



#### To resume playback, press CD ►.

When using the remote control, press CD ►/■.

#### To locate a particular point of a track

During playback, press and hold ►► or ◀◀.

- ►►: Fast forwards the disc.
- ◀◀: Fast reverses the disc.

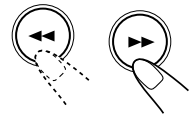

When using the remote control, press and hold ►►/▶▶ or ◀◀/◀◀.

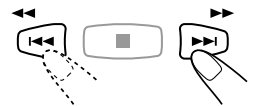

#### To go to another track

##### For Audio CD:

Turn the PRESET +/-, ►►/◀◀ control.

- ►►: Skips to the beginning of the next or succeeding tracks.
- ◀◀: Goes back to the beginning of the current or previous tracks.

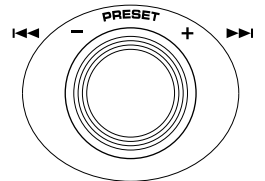

When using the remote control, press ►►/▶▶ or ◀◀/◀◀.

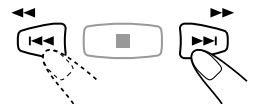



If you turn the PRESET +/-, ►►/◀◀ control (press ►►/▶▶ or ◀◀/◀◀ on the remote control) to select a track while in stop mode



The selected track starts playback.

**For MP3/WMA disc:****When the MP3 playback mode is the TRACK mode**

(See also page 17.)

Turn the PRESET +/-, /|/|<<< control.

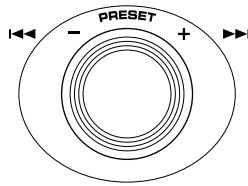
- : Skips to the beginning of the next or succeeding tracks.
- : Goes back to the beginning of the current or previous tracks.

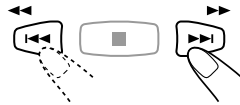
When using the remote control, press /|/|<<< or /|/|<<<.



 **If you turn the PRESET +/-, /|/|<<< control (press /|/|<<< or /|/|<<< on the remote control) to select a track while in stop mode**



The selected track starts playback.



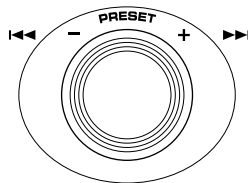

**To go to another album on an MP3/WMA disc****When the MP3/WMA playback mode is the ALBUM mode**

(See also page 17.)

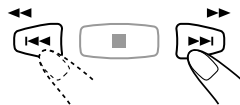
Turn the PRESET +/-, /|/|<<< control.

- : Skips to the beginning of the first track in the next or succeeding albums.
- : Goes back to the beginning of the first track in the previous albums.

When using the remote control, press /|/|<<< or /|/|<<<.

 **If you turn the PRESET +/-, /|/|<<< control (press /|/|<<< or /|/|<<< on the remote control) to select an album while in stop mode**

The first track in the selected album starts playback.

**To go to another track directly using the number buttons****For Audio CD:**

Pressing the number button(s) during playback or while in stop mode allows you to start playing the selected track.

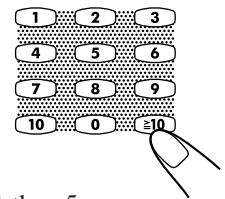

Ex.: For track number 5, press 5.

For track number 15, press  $\geq 10$ , 1 then 5.For track number 20, press  $\geq 10$ , 2 then 0.For track number 32, press  $\geq 10$ , 3 then 2.**For MP3/WMA disc:****• When the MP3/WMA playback mode is the TRACK mode**

(See also page 17.)

Pressing the number button(s) before or during play allows you to start playing the selected track on the disc.

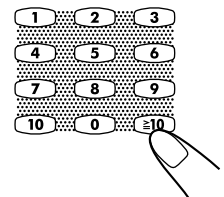

Ex.: For track number 5, press 5.

For track number 15, press  $\geq 10$ , 1 then 5.For track number 20, press  $\geq 10$ , 2 then 0.For track number 32, press  $\geq 10$ , 3 then 2.For track number 123, press  $\geq 10$ ,  $\geq 10$ , 1, 2 then 3.**• When the MP3/WMA playback mode is the ALBUM mode**

(See also page 17.)

Pressing the number button(s) during playback or while in stop mode allows you to start playing the selected track in the current album.

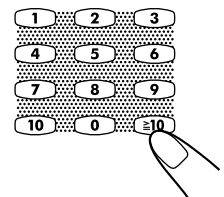

Ex.: For the 5th track in the current album, press 5.

For the 15th track in the current album, press  $\geq 10$ , 1 then 5.For the 20th track in the current album, press  $\geq 10$ , 2 then 0.For the 32nd track in the current album, press  $\geq 10$ , 3 then 2.For the 123rd track in the current album, press  $\geq 10$ ,  $\geq 10$ , 1, 2 then 3.**If your entry is ignored**

If you try to enter a track number that does not exist on the disc or in the album (for example, selecting track 14 in the album that only has 12 tracks), the entry is ignored.

## Changing the MP3/WMA Playback Mode

When playing an MP3/WMA disc, you can choose the playback mode of the MP3/WMA disc as follows:

- **TRACK mode:**  
The unit recognizes only tracks (files). You can play an MP3/WMA disc like an Audio CD.
- **ALBUM mode:**  
The unit recognizes tracks (files) and albums (folders) on an MP3/WMA disc. You can play an MP3/WMA disc according to the way how they are grouped.  
In this mode, you can do the following operations:
  - Turning the PRESET +/-, ►►/◄◄ control (or pressing ►►/►►, ◄◄/◄◄ on the remote control) allows you to skip to the first track of the previous or next albums. (See page16.)
  - Pressing the number button(s) allows you to start playing the selected track in the current album. (See page16.)

### On the remote control ONLY:

Press **MP3/WMA MODE** before or during playing an MP3/WMA disc.



GROUP indicator appears when the MP3/WMA playback mode is the ALBUM mode.

GROUP indicator

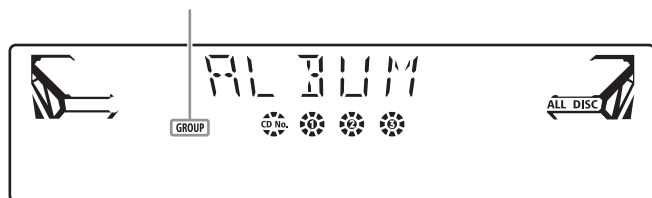

- Each time you press the button, the MP3/WMA playback mode changes between ALBUM and TRACK modes alternately.

## Turning On or Off the Resume Play for MP3/WMA Disc

For an MP3/WMA disc, this unit can store the number of the track that you stopped playback. By pressing CD ► (CD ►/|| on the remote control), you can start playback again from the beginning of the same track—Resume play.

You can turn on and off the resume play for MP3/WMA discs.

### On the remote control ONLY:

Press **RESUME** while in stop mode or during playback of MP3/WMA disc.



- Each time you press RESUME, the resume play turns on and off alternately.



#### If you unplug the AC power cord

The resume play is back to on.



#### The following operations will erase the memory of the track number that you stop the playback

- When pressing CD ▲ to eject the disc.
- When pressing one of the disc number buttons (or DISC SKIP on the remote control) to change the disc to play.

## Programming the Playing Order of the Tracks —Program Play

You can arrange the order of the tracks to playback while in stop mode. **You can program up to 32 tracks.**



**Program play is not available to MP3/WMA discs on this unit**

If a track in an MP3/WMA disc is attempted to be programmed, the track will not be played back, and erased from the stored memory.

**On the remote control ONLY:**

### 1 Load CDs.

- If the current playing source is not CD, press CD ►/||, then ■ before going to the next step.

### 2 Press PROGRAM so that “PROGRAM” appears on the display.

The PROGRAM indicator also lights up on the display.

- All disc playback is selected automatically. You cannot select One disc playback for Program play.



PROGRAM indicator



- If a program has been stored in memory, the program is called up.

### 3 Press one of the disc number buttons (DISC1, DISC2, and DISC3) to select the disc number you want to play.

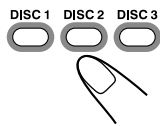

Disc number    Track number    Program step number

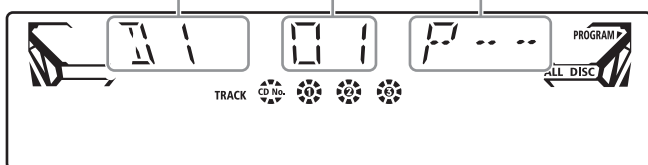

### 4 Press the number button(s) to enter the desired track number.

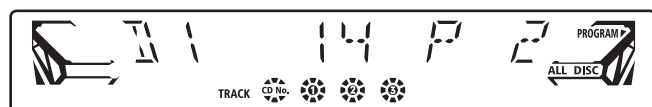
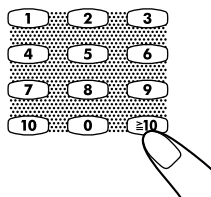

### 5 Program other tracks you want.

- To program tracks from the same disc, repeat step 4.
- To program tracks from a different disc, repeat steps 3 and 4.

### 6 Press CD ►/||.

The tracks are played in the order you have programmed.

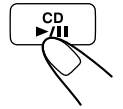

**To stop Program play, press ■.**

The Program play is canceled and the unit enters All disc playback.

(The program you have made is stored in memory until you turn off the unit, eject the carousel, or erase the program.)

- Program play is also canceled when you press ▲.

**To use Repeat play (see page 19) for Program play, press REPEAT after starting Program play.**

### To modify the program

While in program mode, you can erase the last programmed track shown on the display by pressing CANCEL while the playback is stopped.



- Each time you press the button, the last programmed track is erased from the program.

**To add tracks in the program while in stop mode, simply select the disc numbers and/or track numbers you want to add by following steps 3 and 4 of the programming procedure.**

**To check the program while in stop mode, press ►►/►►, ◀◀/◀◀.**

The programmed tracks appear on the display in the programmed (or reverse) order.

- Pressing CD ► (CD ►/|| on the remote control) starts Program play from the first track of the program.

**To erase the entire program, press ■ while in the program mode and the Program play is stopped.**

- Unplugging the AC power cord or ejecting the carousel will also erase the stored memory.



**Turning the power off will not erase the stored memory.**



**If you program a track from an empty tray, or a track number that does not exist on the disc**  
Such program steps will be ignored and erased from the program.



## Playing at Random—Random Play

The tracks of the selected CD can be played at random.

- To use Random play, you have to cancel Program play.

**On the remote control ONLY:**

**1** Load a CD.

**2** Press one of the disc number buttons (DISC1, DISC2 and DISC3) for the disc you want to play, then press ■.

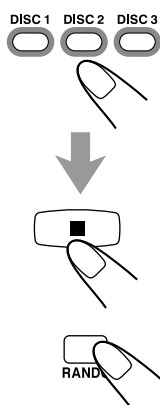

**3** Press RANDOM so that “RANDOM” appears on the display.

- The RANDOM indicator also lights up on the display.
- Activating Random play cancels Repeat play or All disc playback. (One disc playback is automatically selected.)
- For MP3/WMA discs, activating Random play changes the ALBUM mode to the TRACK mode.

RANDOM indicator



- The tracks are played automatically at random. Random play ends when all tracks are played once.

**To stop and cancel Random play, press ■.**

- If you press RANDOM again during play, Random play is canceled and the unit enters All disc playback mode.
- Random play is also canceled when you press ▲.



- If you turn the PRESET +/-, ►►/◄◄ control to the ◄◄ side (press ◄◄/◄◄ on the remote control), playback returns to the beginning of the same track.
- If you turn the PRESET +/-, ►►/◄◄ control to the ►► side (press ►►/►► on the remote control), playback skips to the next track selected randomly.

## Repeating Tracks or CDs—Repeat Play

You can repeat all the CDs, the program or the individual track currently playing as many times as you like.

- Repeat play and Random play cannot be used at the same time.

**On the remote control ONLY:**

**To repeat play, press REPEAT during or before playing.**



- Each time you press the button, Repeat play mode changes as follows, and the following indicator lights up on the display:

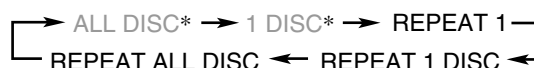

- REPEAT 1:** Repeats one track on one CD.
- REPEAT 1 DISC\*\*:** Repeats all the tracks on one CD.
- REPEAT ALL DISC:** Repeats all the tracks on all the CDs, or all the tracks on the program.

\* See pages 13 and 15.

\*\* REPEAT 1 DISC cannot be selected during Program play.

**To cancel Repeat play, press REPEAT repeatedly until the REPEAT indicator (REPEAT 1, REPEAT 1 DISC or REPEAT ALL DISC) goes off from the display.**

- Repeat play is also canceled in the following cases:
  - When you press ■ or ▲.
  - When you change the source.
  - When you turn off the unit.

## Prohibiting Disc Ejection—Carrousel Lock

You can lock the carrousel to prohibit CD ejection from the unit.

- This operation is possible only while the unit is on with CD selected as the source.

**On the unit ONLY:**

**To prohibit disc ejection, press ▲ while holding ■.**

“LOCKED” appears for a while, and the carrousel is locked.



**If you try to eject CDs**

“LOCKED” appears to inform you that the Carrousel Lock is set.

**To cancel the prohibition and unlock the carrousel, press ▲ while holding ■.**

“UN LOCKED” appears for a while, and the carrousel is unlocked.



**When you unplug the AC power cord or if a power failure occurs**

The setting of the Carrousel Lock will return to the initial setting (UNLOCKED) in a few days.

## Connecting to Your PC

This system is equipped with a USB terminal on the front panel. You can connect your PC to this terminal and enjoy sound reproduced through your PC.

When you connect your PC for the first time, follow the procedures below.

- The system cannot send any signal or data to your PC.

### IMPORTANT

Always set volume to VOL MIN when connecting or disconnecting the other equipment.



DO NOT turn off the unit and disconnect the USB cable while installing drivers and playing back, and for several seconds after your PC recognizes the unit.

### How to install the USB drivers

The following procedures are described using the Microsoft Windows® XP. If your PC is running on a different version of Windows, the screen shown on your PC's monitor will differ from the ones described in the following procedures.

**1 Turn on your PC, and close all the running applications.**

**2 Turn on the unit and press USB/AUX repeatedly to select USB.**



**3 Connect the unit to the PC using a USB cable (not supplied).**

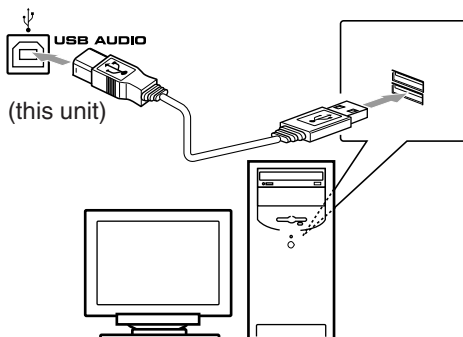

- Use “USB series A plug to B plug” cable when connecting.

**4 The USB drivers are installed automatically.**

- If the USB drivers are not installed automatically, install the USB drivers manually following the instructions displayed on the PC's monitor.

**5 Check if the drivers are correctly installed.**

- 1 Open the Control Panel on your PC: Select [Start] → [Settings] → [Control Panel]
- 2 Click [System] → [Hardware] → [Device Manager] → [Sound, video and game controllers] and [Universal Serial Bus controllers]

- The following window appears, and you can check whether the drivers are installed.

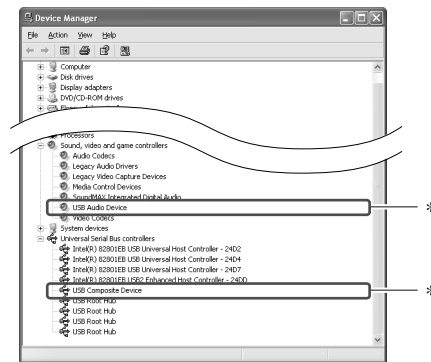

- \* The installed drivers are shown only when the unit is connected to the PC.

### To playback sounds stored on the PC

Refer the manuals supplied with the sound reproduction application installed in the PC.

- Noise and static electricity may stop the sound through the USB connection. In this case, do the following operations:
  - Disconnect and connect the USB cable again.
  - Restart the music software on your PC.
  - Turn off and on the unit.
- Windows® 98SE, Windows Me, Windows 2000 and Windows XP are registered trademarks of Microsoft Corporation.

---

## Connecting the Other Audio Equipment

By using a stereo mini plug cord (not supplied), you can connect the audio equipment with an analog audio output such as an MD player or TV, etc.

- The audio equipment can be used only as a playback device.



- DO NOT connect any equipment while the power is on.
- DO NOT plug in any equipment until all connections are complete.

### 1 Connect the audio equipment to the unit using a stereo mini plug cord (not supplied).

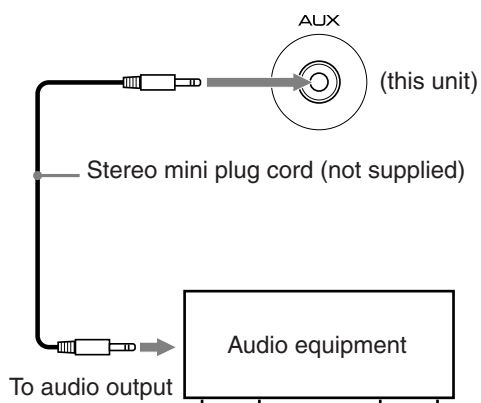

### 2 Turn on the audio equipment.

### 3 Turn on the unit and press USB/AUX repeatedly to select AUX.



AUX

### 4 Start playback of the connected audio equipment.



There are two kinds of timers available—Daily Timer and Sleep Timer.  
 Before using the timers, you need to set the clock built in the unit. (See “Setting the Clock” on page 9.)

## Using Daily Timer

With Daily Timer, you can wake to your favorite music or radio program. You can set the timer whether the unit is on or off.

### How Daily Timer actually works

The unit automatically turns on, sets the volume level to the preset level, and starts playing the specified source when the on-time comes (the  indicator flashes while the timer is operating). Then, when the off-time comes, the unit automatically turns off (stands by).

Daily Timer works every day unless you cancel it.

- There is a time limit in proceeding the following steps. If the setting is canceled before you finish, start from step 1 again.

#### Before you start...

- *When using the tuner as the source to play:*  
 — Make sure to preset a station you want to listen. (See page 12.)
- *When using a CD as the source to play:*  
 — Make sure there is a CD you want to play on the tray currently selected.
- *When using the external component as the source to play:*  
 — Set the timer equipped with the external component at the same time.

### On the remote control ONLY:

**1** Press **CLOCK/TIMER** repeatedly until “TIMER” appears on the display.



“TIMER” appears on the display for a second, then enters into the on-time setting mode.

- Each time you press the button, the clock/timer setting modes change as follows:

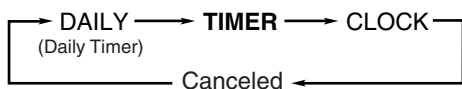

**2** Set the on-time you want the unit to turn on.

- 1 Press or to set the hour, then press SET.
- 2 Press or to set the minute, then press SET.  
 “OFF TIME” appears. Press SET to enter into off-time setting mode.

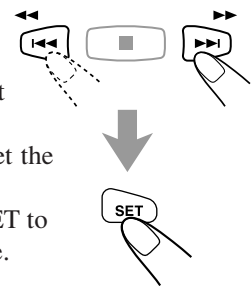

**3** Set the off-time you want the unit to turn off (on standby).

- 1 Press or to set the hour, then press SET.
- 2 Press or to set the minute, then press SET.  
 The unit enters source selecting mode.

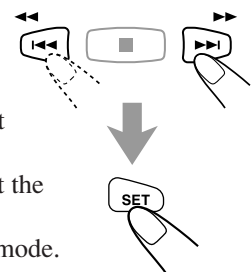

**4** Press or to select the source to play, then press SET.

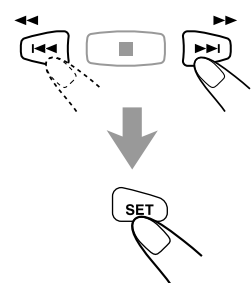

- TUNER FM : tunes in to a specified preset FM station.  
 → go to step 5.
- TUNER AM : tunes in to a specified preset AM station.  
 → go to step 5.
- CD : plays the current disc from the first track.  
 → go to step 6.
- AUX : plays an external source.  
 → go to step 6.
- USB : plays an external source via USB.  
 → go to step 6.



## 5 Select the preset station number.

Press ►►/►► or ◀◀/◀◀ to select the preset station number, then press SET.  
The unit enters volume setting mode.

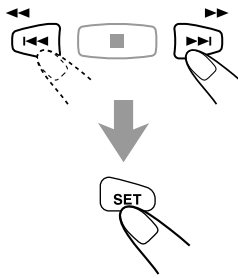

## 6 Press ►►/►► or ◀◀/◀◀ to set the volume level.

- You can select the volume level from VOL MIN, VOL 1 — VOL 30, and VOL MAX.

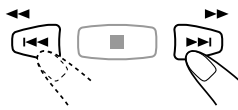

## 7 Press SET to complete the Daily Timer setting.

The settings you have made are shown on the display in sequence for your confirmation.

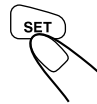

## 8 Press ◻/I STANDBY/ON to turn off the unit (on standby) if you have set the Daily Timer with the unit turned on.



If the unit is turned on when the timer-on time comes Daily Timer does not work.

### To turn on or off Daily Timer after its setting is done

#### 1 Press CLOCK/TIMER repeatedly until "DAILY" appears on the display.



#### 2 To turn off the Daily Timer, press CANCEL.



The DAILY (daily timer) indicator goes off from the display ("OFF" appears for a while). The Daily Timer is canceled, but the setting for the Daily Timer remains in memory until you change it.

#### To turn on the Daily Timer, press SET after step 1.

The DAILY (daily timer) indicator lights up on the display. The settings you have done are shown on the display in sequence for your confirmation.

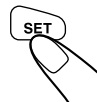

## Using Sleep Timer

With Sleep Timer, you can fall asleep to music. You can set Sleep Timer when the unit is turned on.

### How Sleep Timer actually works

The unit automatically turns off after the specified time length passes.

#### On the remote control ONLY:

#### 1 Press SLEEP.

The time length until the shut-off time appears and the SLEEP indicator starts flashing on the display.

- Each time you press the button, the time length changes as follows:

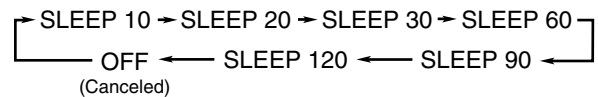

#### 2 Wait for about 3 seconds after specifying the time length.

The SLEEP indicator stops flashing and remains lit.

To check the remaining time until the shut-off time, press SLEEP once so that the remaining time until the shut-off time appears for about 3 seconds.

To change the shut-off time, press SLEEP repeatedly until the desired time length appears on the display.

To cancel the Sleep Timer, press SLEEP repeatedly until "OFF" appears on the display so that the SLEEP indicator goes off from the display.

- Sleep Timer is also canceled when you turn off the unit.

# Maintenance



To get the best performance of the unit, keep your discs and mechanism clean.

## Cleaning the unit

### • Stains on the unit

Should be wiped off with a soft cloth. If the unit is heavily stained, wipe it with a cloth soaked in water-diluted neutral detergent and wrung well, then wipe clean with a dry cloth.

### • Avoid the following since they may cause damage to the unit.

- DO NOT wipe it with a hard cloth.
- DO NOT wipe it strong.
- DO NOT wipe it with thinner or benzine.
- DO NOT apply any volatile substance such as insecticides to it.
- DO NOT allow any rubber or plastic to remain in contact with it for a long time.

## Handling discs



- Remove the disc from its case by holding it at the edge while pressing the center hole lightly.
- Do not touch the shiny surface of the disc, or bend the disc.
- Put the disc back in its case after use to prevent warping.

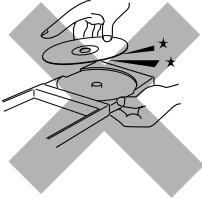

- Be careful not to scratch the surface of the disc when placing it back in its case.
- Avoid exposure to direct sunlight, temperature extremes, and moisture.



### To clean the disc

Wipe the disc with a soft cloth in a straight line from center to edge.



DO NOT use any solvent—such as conventional record cleaner, spray, thinner, or benzine—to clean the disc.

# Troubleshooting



If you are having a problem with your unit, check this list for a possible solution before calling for service. If you cannot solve the problem from the hints given here, or the unit has been physically damaged, call a qualified person, such as your dealer, for service.

Symptom	Cause	Action
Unable to cancel the display demonstration.	Other buttons are pressed to cancel the display demonstration.	Press DEMO on the unit. (See page 8.)
No sound is heard.	Connections are incorrect or loose.	Check all connections and make corrections. (See pages 6 to 7.)
Hard to listen to broadcasts because of noise.	<ul style="list-style-type: none"> <li>Antennas are disconnected.</li> <li>The AM loop antenna is too close to the unit.</li> <li>The FM antenna is not properly extended and positioned.</li> </ul>	<ul style="list-style-type: none"> <li>Reconnect the antennas correctly and securely.</li> <li>Change the position and direction of the AM loop antenna.</li> <li>Extend the FM antenna at the best position.</li> </ul>
The disc sound is discontinuous.	The disc is scratched or dirty.	Clean or replace the disc. (See page 24.)
The carrousel does not open or close.	<ul style="list-style-type: none"> <li>The AC power cord is not plugged in.</li> <li>The carrousel is locked.</li> </ul>	<ul style="list-style-type: none"> <li>Plug the AC power cord.</li> <li>Unlock the carrousel. (See page 19.)</li> </ul>
The disc does not play.	The disc is placed upside down.	Place the disc with the label side up.
The MP3 disc does not play.	<ul style="list-style-type: none"> <li>No MP3 files are recorded on the disc.</li> <li>MP3 files do not have the file extension—.MP3, .Mp3, .mP3, or .mp3 in their file names.</li> <li>MP3 files are not recorded in the format compliant with ISO 9660 Level 1 or Level 2.</li> </ul>	Replace the disc.
The readout time of the MP3 disc is too long.	The readout time varies with the complexity of the recording configuration.	Do not use too many hierarchies and folders when recording. Also, do not record any other types of audio tracks together with MP3 files. (See page 13.)
Operations are disabled.	The built-in microprocessor may malfunction due to external electrical interference.	Unplug the AC power cord and then plug it back in.
Unable to operate the unit from the remote control.	<ul style="list-style-type: none"> <li>The path between the remote control and the remote sensor on the unit is blocked.</li> <li>The batteries are exhausted.</li> </ul>	<ul style="list-style-type: none"> <li>Remove the obstruction.</li> <li>Replace the batteries.</li> </ul>

If you still have a problem, reset the unit.

**On the unit ONLY:**

While in standby, press and hold SOUND TURBO until the display flashes.



The factory default settings are restored and all the settings you have made are erased.

# Specifications

Design and specifications are subject to change without notice.

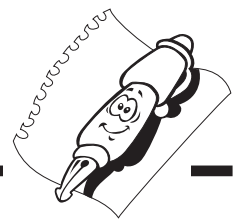

## Amplifier section—CA-MXC55

Output Power

**SUBWOOFERS : 170 W per channel, min. RMS, driven into 3 Ω at 63 Hz with no more than 10% total harmonic distortion**

**MAIN SPEAKERS: 80 W per channel, min. RMS, driven into 6 Ω at 1 kHz with no more than 10% total harmonic distortion**

Audio input sensitivity/Impedance

(at 1 kHz, measured at MAIN SPEAKERS)

AUX : 400 mV/47 kΩ

USB : USB Version 1.1

Speakers/Impedance : Subwoofers : 3 Ω – 6 Ω  
Main speakers : 6 Ω – 16 Ω

## Tuner

FM tuning range : 87.50 MHz – 108.00 MHz

AM tuning range : 530 kHz – 1 710 kHz

## CD player

CD Capacity : 3 CDs

Dynamic range : 85 dB

Signal-to-noise ratio : 85 dB

## General

Power requirement : AC 120 V $\sim$ , 60 Hz

Power consumption : 80 W /136 VA (at operation)

7.3 W (on standby)

1 W (in ECO mode)

Dimensions (approx.): 270 mm × 317 mm × 402 mm (W/H/D)  
(10 <sup>11</sup>/<sub>16</sub> in. × 12 <sup>1</sup>/<sub>2</sub> in. × 15 <sup>7</sup>/<sub>8</sub> in.)

Mass (approx.) : 5.9 kg (13 lbs)

## Supplied accessories

See page 6.

## Speaker section—SP-MXC55

Type : 3-way bass-reflex type

Speaker units : Subwoofer : 16 cm (6 <sup>5</sup>/<sub>16</sub> in.)  
cone ×1

Main Woofer : 10 cm (3 <sup>15</sup>/<sub>16</sub> in.)  
cone ×1

Tweeter : 5 cm (2 in.) cone ×1

Power handling capacity : Subwoofer : 170 W

Main speaker : 80 W

Impedance : Subwoofer : 3 Ω

Main speaker : 6 Ω

Frequency range : Subwoofer : 30 Hz — 1 000 Hz

Main speaker : 100 Hz — 20 000 Hz

Sound pressure level : Subwoofer : 74 dB/W•m

Main speaker : 81 dB/W•m

Dimensions (approx.) : 220 mm × 435 mm × 316 mm (W/H/D)  
(8 <sup>11</sup>/<sub>16</sub> in. × 17 <sup>13</sup>/<sub>16</sub> in. × 12 <sup>1</sup>/<sub>2</sub> in.)

Mass (approx.) : 5.7 kg (12.6 lbs) each

# **TO OUR VALUED CUSTOMER** ———

THANK YOU FOR PURCHASING THIS JVC PRODUCT.

WE WANT TO HELP YOU ACHIEVE A PERFECT EXPERIENCE.

**NEED HELP ON HOW TO HOOK UP?  
NEED ASSISTANCE ON HOW TO OPERATE?  
NEED TO LOCATE A JVC SERVICE CENTER?  
LIKE TO PURCHASE ACCESSORIES?**

**JVC<sup>®</sup> IS HERE TO HELP!**  
**TOLL FREE: 1(800)252-5722**  
**<http://www.jvc.com>**

Remember to retain your Bill of Sale for Warranty Service.

————— **Do not attempt to service the product yourself** —————

**Caution**

To prevent electrical shock, do not open the cabinet.

There are no user serviceable parts inside.

Please refer to qualified service personnel for repairs.

---



# LIMITED WARRANTY

AUDIO-1 **USA ONLY**

**ONLY FOR PRODUCT PURCHASED IN U.S.A.**

JVC COMPANY OF AMERICA (JVC) warrants this product and all parts thereof, except as set forth below ONLY TO THE ORIGINAL RETAIL PURCHASER to be FREE FROM DEFECTIVE MATERIALS AND WORKMANSHIP from the date of original purchase for the period shown below. ("The Warranty Period")

PARTS	<b>1 YR</b>	LABOR	<b>1 YR</b>
-------	-------------	-------	-------------

**THIS LIMITED WARRANTY IS VALID ONLY IN THE FIFTY (50) UNITED STATES, THE DISTRICT OF COLUMBIA AND IN THE COMMONWEALTH OF PUERTO RICO.**

**WHAT WE WILL DO:**

If this product is found to be defective within the warranty period, JVC will repair or replace defective parts with new or rebuilt equivalents at no charge to the original owner. Such repair and replacement services shall be rendered by JVC during normal business hours at JVC authorized service centers. Parts used for replacement are warranted only for the remainder of the Warranty Period. All products may be brought to a JVC authorized service center on a carry-in basis. Color televisions with a screen size of 27" or greater qualify for in-home service. In such cases, a technician will come to your home and either repair the TV there or remove and return it if it cannot be repaired in your home.

**WHAT YOU MUST DO FOR WARRANTY SERVICE:**

***Please do not return your product to the retailer***

**Instead, return your product to the JVC authorized service center nearest you. If shipping the product to the service center, please be sure to package it carefully, preferably in the original packaging, and include a brief description of the problem(s). Please call 1-800-252-5722 to locate the nearest JVC authorized service center. Service locations can also be obtained from our website <http://www.jvc.com>. If your product qualifies for in-home service, the service representative will require clear access to the product.**

If you have any questions concerning your JVC Product, please contact our Customer Relations Department at 800-252-5722

**WHAT IS NOT COVERED:**

This limited warranty provided by JVC does not cover:

1. Products which have been subject to abuse, accident, alteration, modification, tampering, negligence, misuse, faulty installation, lack of reasonable care, or if repaired or serviced by anyone other than a service facility authorized by JVC to render such service, or if affixed to any attachment not provided with the products, or if the model or serial number has been altered, tampered with, defaced or removed;
2. Initial installation, installation and removal from cabinets or mounting systems.
3. Operational adjustments covered in the Owner's Manual, normal maintenance, video and audio head cleaning;
4. Damage that occurs in shipment, due to act of God, and cosmetic damage;
5. Signal reception problems and failures due to line power surge;
6. Video Pick-up Tubes/CCD Image Sensors are covered for 90 days from the date of purchase;
7. Accessories;
8. Batteries (except that Rechargeable Batteries are covered for 90 days from the date of purchase);
9. Products used for commercial purposes, including, but not limited to rental.

There are no express warranties except as listed above.

THE DURATION OF ANY IMPLIED WARRANTIES, INCLUDING THE IMPLIED WARRANTY OF MERCHANTABILITY, IS LIMITED TO THE DURATION OF THE EXPRESS WARRANTY HEREIN.

JVC SHALL NOT BE LIABLE FOR ANY LOSS OF USE OF THE PRODUCT, INCONVIENCE, OR ANY OTHER DAMAGES, WHETHER DIRECT, INCIDENTAL OR CONSEQUENTIAL (INCLUDING, WITHOUT LIMITATION, DAMAGE TO TAPES, RECORDS OR DISCS) RESULTING FROM THE USE OF THIS PRODUCT, OR ARISING OUT OF ANY BREACH OF THIS WARRANTY. ALL EXPRESS AND IMPLIED WARRANTIES, INCLUDING THE WARRANTIES OF MERCHANTABILITY AND FITNESS FOR PARTICULAR PURPOSE, ARE LIMITED TO THE WARRANTY PERIOD SET FORTH ABOVE.

Some states do not allow the exclusion of incidental or consequential damages or limitations on how long an implied warranty lasts, so these limitations or exclusions may not apply to you. This warranty gives you specific legal rights and you may also have other rights which vary from state to state.

JVC COMPANY OF AMERICA  
 DIVISION OF JVC AMERICAS CORP. <http://www.jvc.com>  
 1700 Valley Road  
 Wayne, NJ 07470

REFURBISHED PRODUCTS CARRY A SEPARATE WARRANTY, THIS WARRANTY DOES NOT APPLY. FOR DETAIL OF REFURBISHED PRODUCT WARRANTY, PLEASE REFER TO THE REFURBISHED PRODUCT WARRANTY INFORMATION PACKAGED WITH EACH REFURBISHED PRODUCT.

**For customer use:**

Enter below the Model No. and Serial No. which is located either on the rear, bottom or side of the cabinet. Retain this information for future reference.

Model No. : \_\_\_\_\_ Serial No. : \_\_\_\_\_

Purchase date : \_\_\_\_\_ Name of dealer : \_\_\_\_\_

**JVC**